

EXPOVISION

EXPVISION

STAGES

*Our range is constantly
expanding, if there are
things you don't see,
please ask and we will
see how we can help you.*

Stage Trailer 48m²



PRODUCT SPECS :

Podiumwagen 8 x 6 meter x 5,1 hoog
 Podiumwagen gesloten afmetingen : 9,6 x 2,5 x 3,8h
 Gewicht : 2500 kg
 Podium hoogte : 1 meter
 Clearance : 3,9m front and 3,3m back
 Wings max. gewicht : 300kg/wing
 Roof max. load gewicht : 1000 kg
 Vloer : max. 500kg/m²
 1 podium trap

Opbouwtijd : 60 min / 2 pers.
 Opbouwtijd met wings : 75 min / 2 pers

OPTIES :

- Transport , berekend per locatie
- Side Wings U vorm. (RM : ST48WING)
- Side Wings T , met geprinte front banner op maat.
- Extra Trappen
- Stage Ramp

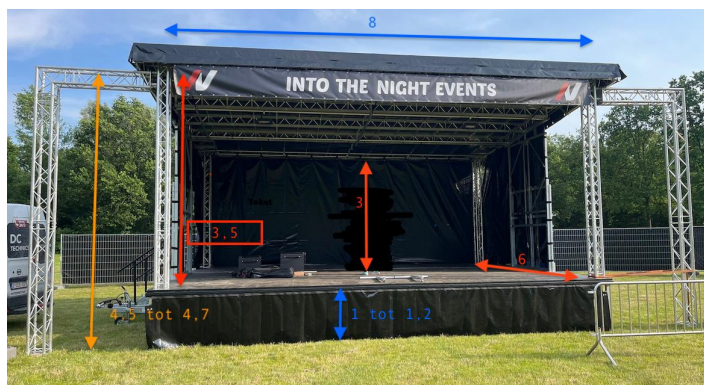

DRY HIRE : NO - Only with Expovision crew

RM PRODUCT CODE : ST48

RENTAL PRICE : Start at 1250,00

CATEGORY : STAGE

STAGE ROOF - Prolyte Arc 8 x 6 48m²



PRODUCT SPECS :

Prolyte Arc roof 8 x 6
Podium 8x6m
1 Podium Trap
4 Beton Gewicht

OPTIES :

- Transport , berekend per locatie
- Side Wings U vorm.Max.belasting 150kg
- Side Wings T , met geprinte front banner op maat.
- Extra Trappen
- Stage Ramp

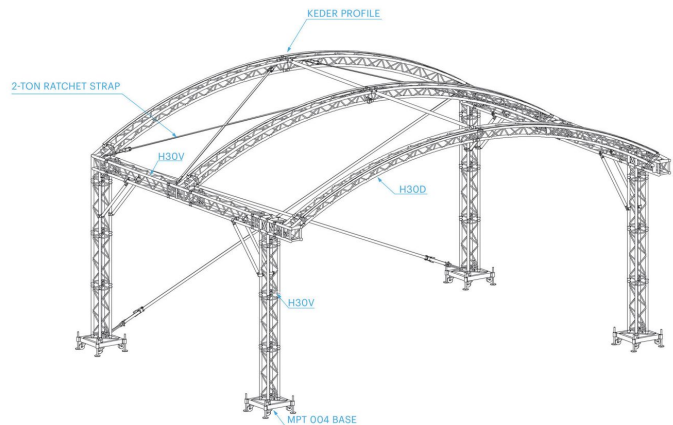

DRY HIRE : NO - Only with Expovision crew

RM PRODUCT CODE : SR48

RENTAL PRICE : Start at 1750,00

CATEGORY : STAGE

STAGE ROOF - Prolyte Arc 6 x 4 24m²



PRODUCT SPECS :

Stage roof 6,6 x 4,7 meter Grijs
Dekzeil + 2 zijkanten + 1 achterkant
Podium : 1 meter hoog 6 x 4 meter
1 podium trap
4 beton gewicht

OPTIES :

- Transport , berekend per locatie
- Side Wings U vorm. Max. belasting 150kg (SR24WING)
- Side Wings T , met geprinte front banner op maat.
- Extra Trappen
- Stage Ramp

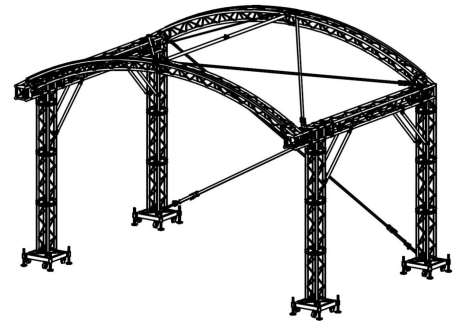

DRY HIRE : NO - Only with Expovision crew

RM PRODUCT CODE : SR24

RENTAL PRICE : Start at 1250,00

CATEGORY : STAGE

Small ROOF - Prolyte 5,7 x 3 (DJ roof)



PRODUCT SPECS :

Small roof 5,7 x 3 meter x 3m H Black / Sand
Roof Black Stretch
+- 18m²

2 beton gewicht 340

OPTIES :

- Transport , berekend per locatie
- Banners op maat geprint.

DRY HIRE : NO - Only with Expovision crew

RM PRODUCT CODE : SMALLR18

RENTAL PRICE : Start at 650,00

CATEGORY : STAGE

Stage Trailer MOB 108 108m²



PRODUCT SPECS :

De mob108 is een mobiel podium opgebouwd op een enkel assige oplegger van 22T
Gesloten/rijdende toestand: oplegger van 13m60 lang + trekker, 2m55 breed, vrije hoogte 4m.

Opgebouwd:

Podiumvloer 13m60 op 8m.
 Vloerhoogte variabel tussen 1m60 en 2m.
 Vloerbelasting max. 350kg/m².
 Clearance 5m50.
 Dakzeil in polyester, binnen met zwarte rubberlaag.
 Luifel vooraan.
 Zijzeilen in zwart pvc gecombineerd met PE agroflor. B
 randvertragend DIN4102 B1
 Dakbelasting max. 4000kg
 In het podium zijn riggingpunten voorzien, plan is beschikbaar.
 Er zijn mogelijkheden om geluid te stacken of in te hangen.
 Er is 1 trap voorzien en een laadram van 1m breed.
 Werklicht dmv hpl lampen.
 Opbouw en afbraak kan autonoom, voor het werklicht is er een stopcontact 240V nodig.
 Dit podium wordt hydraulisch pas gesteld en opent ook hydraulisch.
 Opbouw in 3u en afbraak in 2u30 door 2 personen.

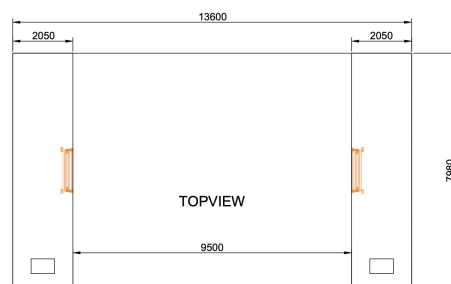

DRY HIRE : NO - Only with Expovision crew

RM PRODUCT CODE : STM0B108

RENTAL PRICE : Start at 4950,00

CATEGORY : STAGE

Line Array Layher TOWER 2m x 2 m - 6m High

NEW



PRODUCT SPECS :

2,07 x 2,07 x 6,00 High
Rain cover

DRY HIRE : NO - Only with Expovision crew

RM PRODUCT CODE :

RENTAL PRICE : Price on demand

CATEGORY : STAGE

Regie Tent Small

3 x 3 m

NEW



PRODUCT SPECS :

3 x 3 m

DRY HIRE : YES

RM PRODUCT CODE : SREG33

RENTAL PRICE : 60,00

CATEGORY : STAGE

Crowd control Barrier Stage Barrier

NEW



PRODUCT SPECS :

Crowd Control Barrier

Materiaal : Aluminium
Breedt : 100 cm
Hoogte : 109 cm
Diep : 109 cm
Met platform voor beveiliging.



Deur met Kabeldoorvoer

DRY HIRE : YES

RM PRODUCT CODE :

RENTAL PRICE : Start at 18,00 / m in dry hire

CATEGORY : STAGE

STAGE DECK Prolyte

NEXT DECK Next

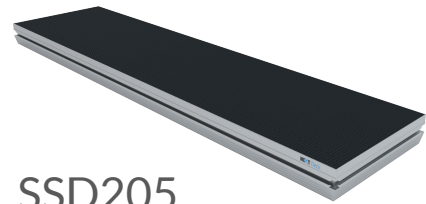
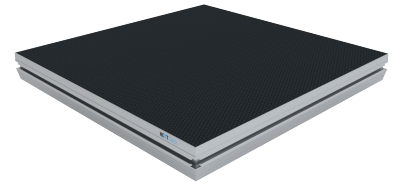
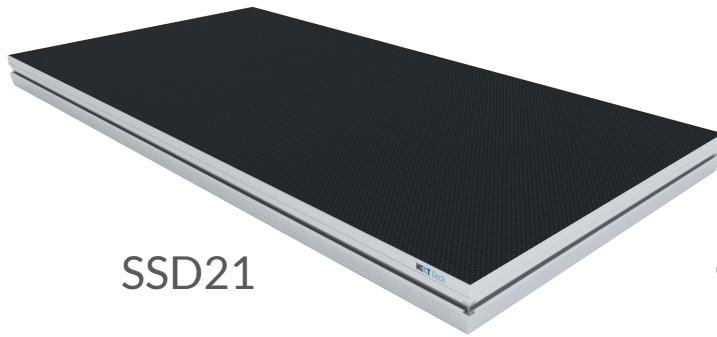

PRODUCT SPECS :

Black Finish

Available in: 2 x 1 m
2 x 0,5 m
1 x 1 m

Calculated with 1/10 of the vertical load transferred into a horizontal load (conform DIN 15921 / EN 13814)

Loading types (for all decks except Acrylic)

Uniformly distributed load	750 kg/m ²
Pointload F1	350 kg
Pointload F2	210 kg
Pointload F3	500 kg

The pointload should be applied to a minimum area of 50 x 50 mm.
Pointload to be placed as indicated on drawing.
1 pointload total allowed.

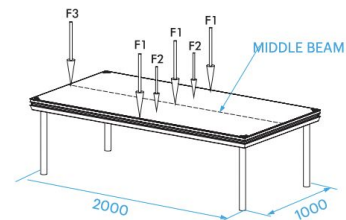

DRY HIRE : YES

RM PRODUCT CODE : SSD21 SSD11 SSD205

RENTAL PRICE : 15,00 (all types)

CATEGORY : STAGE

STAGE LEGS Prolyte

STAGE LEGS Next



PRODUCT SPECS :

Available :

20 cm
40 cm
60 cm
80 cm
100 cm

ADJUSTABLE form 90 → 140 cm

DRY HIRE : YES

RM PRODUCT CODE : SL20 SL40 SL60 SL80 SL100 SL90140

RENTAL PRICE : 0,5 / Pcs - ADJUSTABLE 1,25 / Pcs

CATEGORY : STAGE

ROLLING RISER LEGS



PRODUCT SPECS :

Available :

40 cm

60 cm

DRY HIRE : YES

RM PRODUCT CODE : RRL40S RRL40D RRL60S RRL60D

RENTAL PRICE : 1,5 / Pcs

CATEGORY : STAGE

DECK CLAMP
Prolyte

DECK CLAMP
Next

NEW

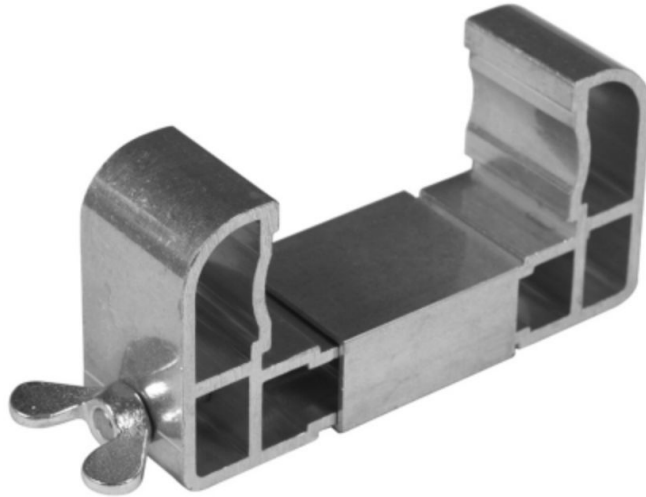

PRODUCT SPECS :

Deck to deck clamp

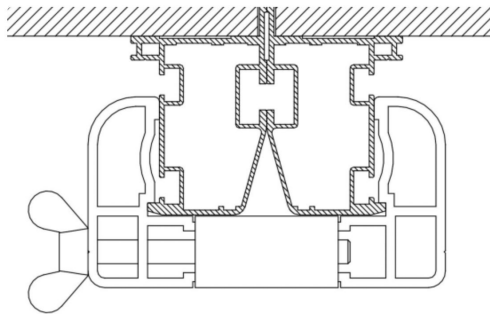

DRY HIRE : YES

RM PRODUCT CODE : SDTDC

RENTAL PRICE : 0,80

CATEGORY : STAGE

DECK RAILING
Prolyte

DECK RAILING
Next

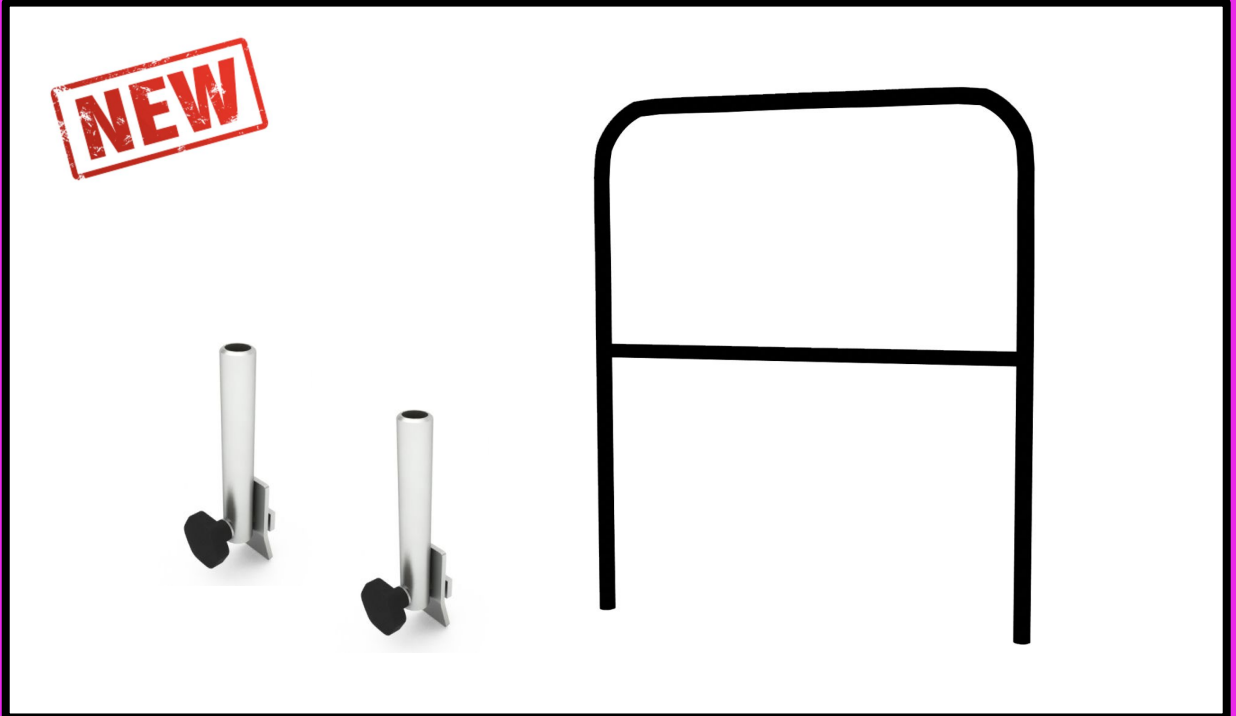

PRODUCT SPECS :

Deck Railing 1 m + 2 adaptor

Deck Railing 2 m + 2 adaptor



DRY HIRE : YES

RM PRODUCT CODE : SDRAIL1 SDRAIL2

RENTAL PRICE : 6,00 / pcs (1) 10,00 / pcs (2)

CATEGORY : STAGE

STAGE STAIR Expovision



PRODUCT SPECS :

Adjustable stair 20 - 40 - 60 - 80 - 100 cm

DRY HIRE : YES

RM PRODUCT CODE : STRAP100

RENTAL PRICE : 30,00

CATEGORY : STAGE

CONCRETE COUNTERWEIGHT

340 kg



PRODUCT SPECS :

Counter weight 340 kg

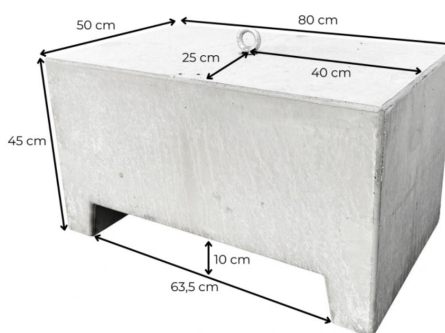

DRY HIRE : YES

RM PRODUCT CODE : SCON340

RENTAL PRICE : 20,00

CATEGORY : STAGE

CONCRETE COUNTERWEIGHT

145 kg



PRODUCT SPECS :

Counter weight 145 kg

DRY HIRE : YES

RM PRODUCT CODE : SCON145

RENTAL PRICE : 10,00

CATEGORY : STAGE